



WIRE-TRADE

**Wire- Trade UG
(Haftungsbeschränkt)**

Am Schöps 103
02829 Markersdorf, Germany
Tel. +49 (0) 35829 123610
www.wire-trade.de

Original operating instructions

Cutting machine

WT 6100





IMPORTANT!

Please read these operating instructions carefully so that you can use the Cutting machine **WT 6100** can be operated correctly from the first moment and can work safely!

In addition to the above safety instructions, the statutory safety regulations of the respective country and the operation in which the machine is used must be observed at all times.

The measuring tape installed on the machine is only used for length checking

Contents

1. Intended use	3
2. Specifications	4
3. Warnings	5
4. Initial starting up	6
5. Instruktionen	7
6. Programming	11
7. Maintenance instructions	13
8. Error list	14
9. Imprint	15
10. Spare parts	16
11. Notes	17
12. Declaration of conformity	18
13. Principle switch safety function	19



1. Intended use

The cutting machine is designed to cut cables, hoses, flat strip lines and strands to a preset length. The machine can be material with a thickness of max. 12 mm diameter and max. 100 mm width. Copper strands can be machined up to a cable cross section of 10 mm².

The material is inserted into the machine and clamped by the operator. The machine automatically cuts the material, depending on the parameters set.

All instructions from the operating instructions must be observed and the maintenance plan must be followed. The use of the machine is permitted in the commercial sector.

Operation of the machine in a potentially explosive atmosphere is prohibited.

Under no circumstances may steel wires or similar solid materials be cut, which would result in destruction of the knives.

Unauthorised modifications to the machines are prohibited for safety reasons..



Before the first start-up and at appropriate intervals, the protective devices must be checked for function by a qualified person. This concerns the emergency stop device and the two protective covers .

The WT 6100 cutting machine is to be used only for its intended use. The machines must be in a completely sound and safe condition.

All persons involved in the commissioning, operation and maintenance of the machine must be adequately qualified and observe these operating instructions carefully. They must be able to detect hazards.

The protective covers must under no circumstances be altered, removed or remedied by alterations..

The cutting machine may only be operated with the protective covers closed.

The mains plug must be disconnected from the mains before carrying out any repairs or cleaning and before opening the machine.

The safety devices must be tested before commissioning and in the interval of 4 weeks.

The material to be cut is fed via a transport table with two laterally adjustable guide rails. A sensor, controlled by a lever arrangement, monitors the material flow and stops the cutting machine immediately if the material is not present. The material to be cut is transported by means of a roller feed between the blade arrangement. The upper roller is raised by pressing a bracket so that the material to be cut can be simply inserted between the roller arrangement. The lower roller is controlled by a stepper motor. By means of a gearwheel, the upper roller engages in the lower roller in the closed state and is simultaneously moved with the lower roller. Rolling rubber is used for better rolling friction.

The blade arrangement consists of a lower, fixed flat blade and an upper flat blade which is movable vertically via a guide rail.

**2. Technical data WT6100**

WT 6100		TECHNICAL DATA
Wire Size	max. 10 mm ² copper wire	
Material thickness	min. 0,1mm	
Material thickness	max. 12 mm	
Material width	max. 100 mm	
cutting length	0.1 - 99999 mm	
performance (L = 100 mm)	100 st./min	
Cutting speed	1,5 m/s in 9 Stufen	
program storage	100 intern	
Weight	32 kg	
Dimensions (L x W x H)	350 x 260 x 250 mm	
Power supply	110 V - 230 V; 50 Hz / 60 Hz; 120 VA	
operation noise	< 71 db	



3. Warnings

Be sure to read the operating instructions carefully before operating this unit and keep these instructions for future reference. Use the machine only for its intended purpose. The machine may only be operated by trained personnel, in compliance with the legal safety regulations.



Improper use of the device could result in serious personal injury and property damage!

Observe the intended use according to the operating instructions. Furthermore, the operational conditions must be considered. Compensation claims for material or personal injury are excluded if one of the following causes is responsible:

- Machine has not been used for the intended application.
- Incorrect installation, commissioning, operation and maintenance.
- Operation with defective safety devices or improperly installed or non-functioning safety and protective devices.
- Disregard the instructions in the operating instructions with regard to Installation, commissioning and maintenance..
- Unauthorised modifications to the device or accessories.
- Improper repair of the unit by unauthorised personnel.
- No use of original spare parts.
- Events caused by foreign bodies or force majeure.

Check the existing voltage - especially during initial commissioning - before connecting the device to the mains in order to avoid damage to the device! The connection socket must be earthed so that electrical shock is prevented in the event of a possible electrical fault.

Only operate the device if the mains voltage is present. In the case of mains faults during operation and resulting malfunctions, the device must be switched off immediately or the machine disconnected from the mains.

Disconnect the device completely from the power supply before carrying out any maintenance or conversion work.



There is a danger to life when touching live parts!

Danger of cutting injuries and bruises!

Protective devices may only be removed if the machine is at a standstill and the machine is switched off electrically. The housing or protective cover may only be removed by qualified personnel during maintenance work. Operation without protective cover is not permitted!

Please note the following points when choosing the workplace:

Ensure a stable voltage supply and avoid multiple use of the same outlet with other devices.

Lighting sources and brightness should meet the workplace requirements.

The cutting machine must be placed on a level surface and, if necessary, secured against slipping.

The machine may only be used in low - dust rooms with low electromagnetic fields.

Fields and not in a corrosive atmosphere.



Keep the device away from heat, moisture, and combustible material!



4. Initial operation

Before the Installation

Carefully unpack the machine.

Check the cutting machine for completeness and any damage.

In the event of damage, the packaging must always be kept for the purpose of clarification.

The operating instructions must be accessible to the operator at all times.

Follow exactly the steps in the operating instructions.

Before using the appliance for the first time, read this manual carefully and completely.

They are liable for all damages that result from ignoring the instructions for use or restrictions of use, due to negligence or intent.

The machine must be positioned in such a way that sufficient space is left for the material feed and output to the left and right.

Machine connected to mains voltage with 110 V - 230 V; 50 Hz / 60 Hz connection. If the mains voltage is unstable, countermeasures may have to be taken..



5. Controls

Top view

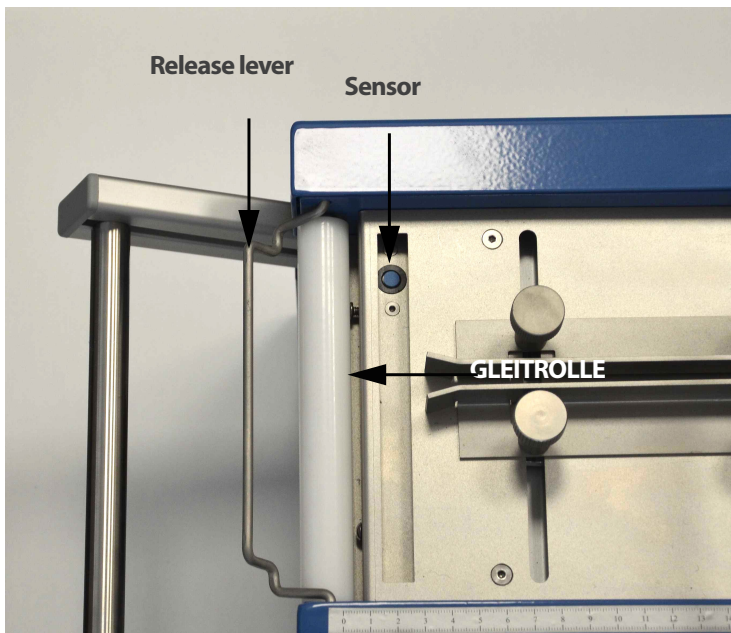
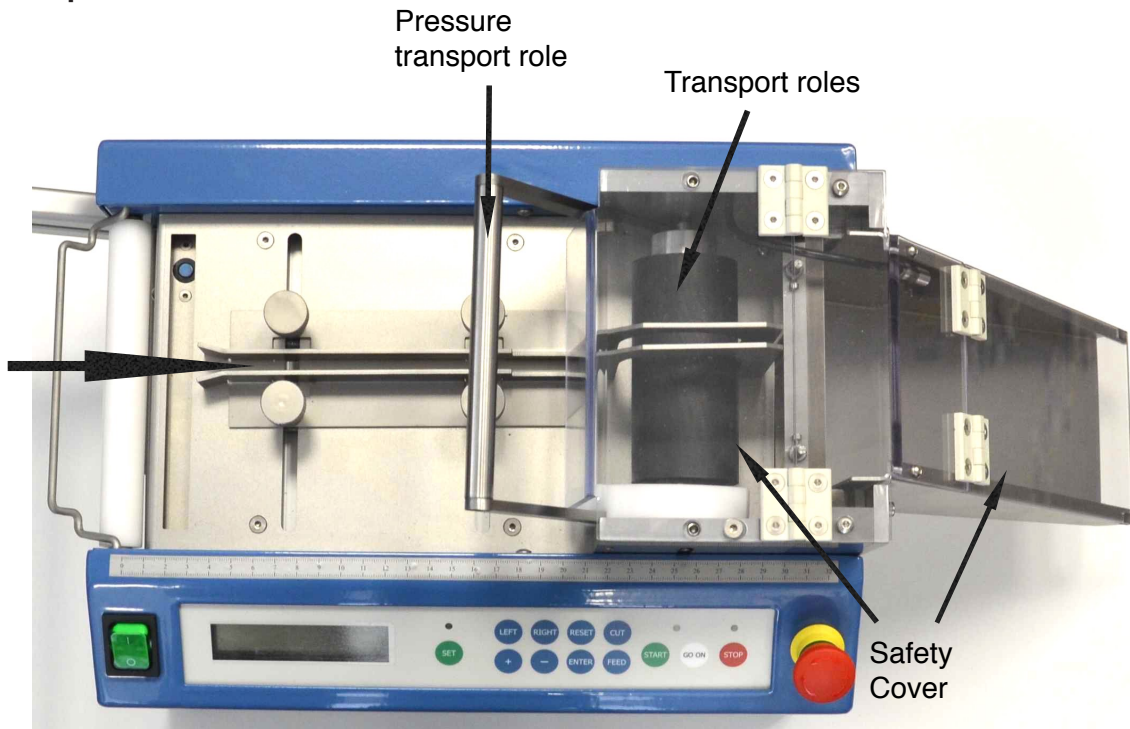

.....
 The material to be cut must be fed over the guide roller.

The release lever must be located above the material, so that it falls on to the sensor only if the material is missing.

When the end monitor is triggered, the machine is immediately stopped.

The message must be cleared by the stop key.



Guiding rails

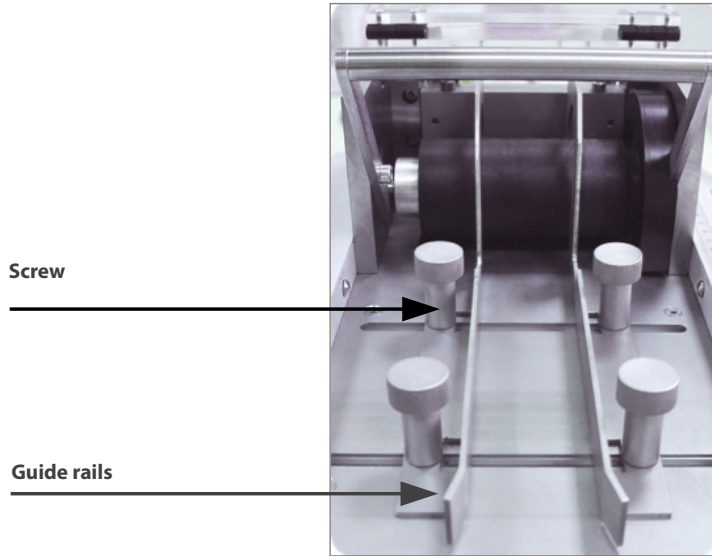

.....
The cutting material is guided between the two guide rails.

For adjustment, the knurled screws must be loosened slightly so that the rail can be moved freely within the groove.

The distance between the rails must be adjusted in such a way that the cutting material is guided without clamps.

For a right-angled cutting edge, the rails must be aligned parallel to the guide table.

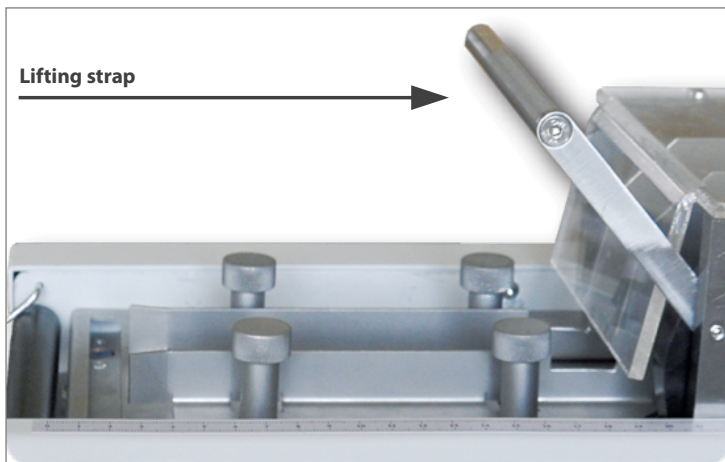

To insert the cutting material, the upper transport roller is moved upwards by pressing the lifting strap.

The contact pressure of the upper transport roller is freely adjustable via the spring-loaded pressure screws.

.....



Elektronic sensors for your security

The **WT6100** is equipped with four safety sensors. The first sensor detects missing material. The second sensor checks the proper function of the protective cover. The third sensor checks whether the outlet shaft is closed. The fourth sensor monitors the blade. If the material to be cut is too hard for the machine, the knife sensor detects this and the knife opens again to avoid damage to the machine.

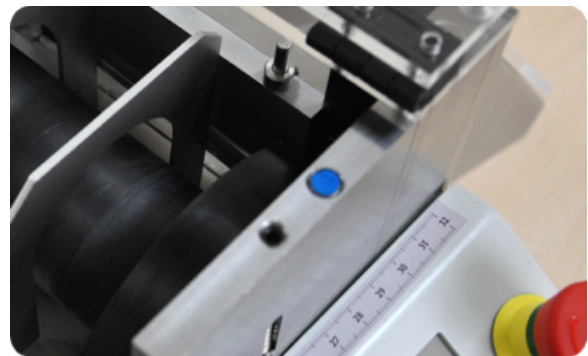
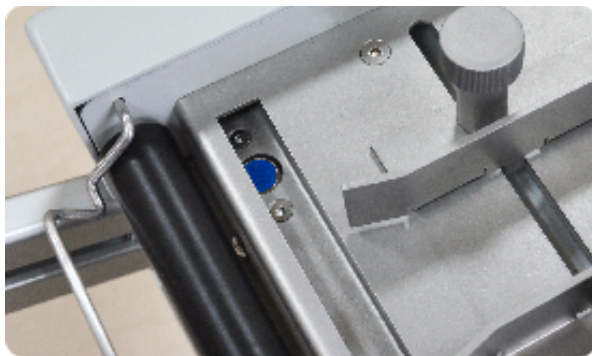
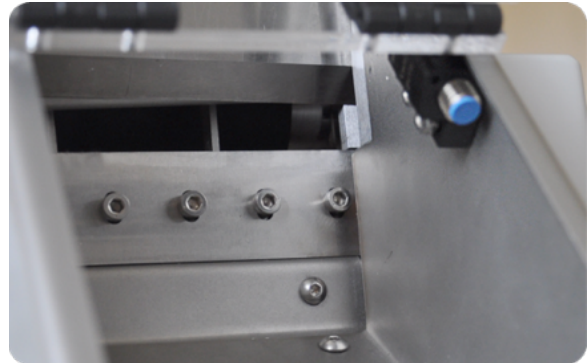

The machine can not be started when the protective cover or cover of the spout is open. A corresponding error message is displayed on the display, which must be cleared with the STOP key.

When opening the protective cover or the cover of the outlet, the machine stops immediately. After closing the covers, the STOP button must be acknowledged. If the cutting operation has already begun, the knife opens and the message "knife error" appears. After a proper test of the material, the STOP key must be acknowledged.

The cutting operation can be continued with the GO-ON button.

If no material is available, the cutting process is immediately stopped and the message "End of material" appears in the display. After the material has been fed again, the process can be continued with the GO-ON button.



Description keyboard



SET button to select the memory location or setting parameters. To select the required parameter, the key is pressed until the cursor is on the display in the respective parameter area.



Press the LEFT or RIGHT key to move the cursor to the left or right step by step in the area of the selected parameter.



Use these keys to change the selected value (0-9) of the parameter.



RESET button resets the parameters to zero.



The ENTER key is used to store the settings. The parameters are written to the internal memory.



CUT key performs a zero cut.



Single feed with the last set length.



The selected program is started and the specified lot size is processed.



Restart after manual STOP or by end-control release. The accumulated quantity is not deleted.



Machine stops after completion of the last complete cycle. Error messages are deleted.

Display



PROGRAM NUMBER	LENGTH	PIECES	FEED SPEED
----------------	--------	--------	------------



Serial Number

WT 6100
SN:610XX REV 1.X.X

Language

LANGUAGE
ENGLISH

Counter

STATE OF COUNTER
00000000000000002500

.....

The **WT 6100** has an additional configuration menu. The menu is displayed when the 'SET' key is pressed when the machine is switched on. Press the 'ENTER' key to enter the next menu point, the ,RESET' key closes the menu. Use the '+' and '-' keys to change the values.

The first screen shows the serial number and the software version. The next menu item is used to change the language. In the next point, the total cutting number of the machine appears. This can not be reset.

.....

6. Programming

Programming example		
Program number	(M)	3 3
Length		2 5 0 , 5 mm
Quantity		5 0 0 Stück
Speed.	(S)	4 (range 1 - 9)

The machine can be programmed in a very simple way. The "SET" button is pressed repeatedly between the five parameters. Press the "ENTER" key to exit the menu.

To change the value, use the "LEFT and RIGHT" and "+, -" buttons. To reset the previously entered values, simply press the "RESET" button. After setting the desired value, press the "SET" button to enter the next value.

The **WT 6100** can store 100 programs. The lower part of the display shows the setpoint number, directly above the quantity to be cut. When the machine is stopped, it

is possible to use the "GO ON" button to further cut the selected number of pieces or to start again with the "START" button.

The feed speed can be selected from "1 to 9". Step 5 is preselected here.

At the end, the input values are accepted by pressing the "ENTER" key.

If the cut length deviates from the set value, the "+" and "-" keys can be used to change the value in steps of 0.1 mm.



1. Press the "SET" button to go to the first menu item.

```
M LENGTH COUNT S
00 00000,0 00000 5
```



2. Enter the number of the memory location.

```
M LENGTH COUNT S
33 00000,0 00000 5
```

3. Press the "SET" button to go to the first menu item.

```
M LENGTH COUNT S
33 00000,0 00000 5
```

4. Input 250,5

```
M LENGTH COUNT S
33 00250,5 00000 5
```

5. Press the „SET" button to set the number of units to enter.

```
M LENGTH COUNT S
33 00250,5 00000 5
```

6. Input 500

```
M LENGTH COUNT S
33 00250,5 00500 5
```

7. Press the "SET" button to set the feed speed.

```
M LENGTH COUNT S
33 00250,5 00500 5
```

8. Input 4

```
M LENGTH COUNT S
33 00250,5 00500 4
```

Use the "ENTER" key to save the values and exit the menu.

The values are now stored under the program number. By entering the program number, you can recall and change the values at any time.

```
M LENGTH COUNT S
33 00250,5 00500 4
```



7. Maintenance

Environment
<p>Always use the machine in a clean environment.</p> <p>During prolonged downtime, the machine must be stored in a dry, dust-proof place.</p>
Cleaning
<p>Clean the machine with a dry, soft cloth.</p> <p>Under no circumstances may solvents or aggressive cleaners be used.</p> <p>Do not use compressed air to clean the working area! Foreign bodies could get into the subassemblies or machine and impair the function.</p>
Recurring Maintenance
<p>The machine is low-maintenance and long-lasting.</p> <p>One defined must be</p> <p>Removing material residues and soiling on transport rollers, knives, etc..</p>
Repair Work
<p>All repairs must only be carried out by qualified personnel. For damage e.g. No liability shall be assumed for faulty design.</p> <p>Never disassemble the machine. This is only permitted by trained personnel.</p>
Shipping
<p>Only the original packaging should be used to send the machine in order to avoid transport damage.</p>



8. Error list

Error description	Error cause	Error solving
Deviation target / actual of the cut length	Required pulling force too strong Material-induced slip with constant deviation Wear on transport rollers	Pre-feeding a feeding device or unwinding aid Change the set values Replace the transport rollers
No right-angled cutting edge	Guide rails are not aligned parallel to the guide table	Align the guide rails
Irregular cutting edge	Wear on the knives	Replace the blade
Undefined operating status (without alarm)	Program fault due to faulty mains voltage use.	Press the reset button if there is a fault Switch off the machine and after 2 min. Switch on again if there is a fault Contact Customer Service
No function and no LCD display with an existing mains voltage	Device protection	Replace fuse insert



9. Imprint

Wire- Trade UG (Haftungsbeschränkt)

Am Schöps 103
02829 Markersdorf, Germany
Tel. +49 (0) 35829 123610
www.wire-trade.de

General

This operating manual was prepared by Wire- Trade UG in October 2019 .

Guidelines







This operating manual has been developed in accordance with Directive 2006/42 / EC of the European Parliament
And the Council of 17 May 2006 on machinery and amending Directive 95/16 / EC.

Contact

If you have any questions or suggestions, please do not hesitate to contact us.

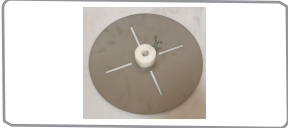
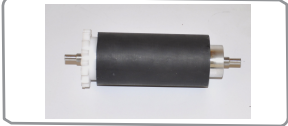
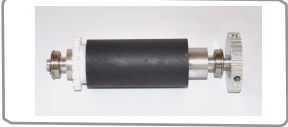

10. Spare parts WT6100

Item number		
NM-10189	Safety cover. WT6100	
Item number		
NM-10121	Screws for Guiding rails	
Item number		
NM-10034	Lifting strap	
Item number		
NM-10188	Disk. WT6100	
Item number		
NM-10085-W	Upper role WT6100	
Item number		
NM-10086-W	Lower role WT 6100	
Item number		
NM-10120	Guiding rails	
Item number		
NM-10012	Lower Knife	
Item number		
NM-10006	Upper knife	
Item number		
NM-10039-W	Gear cover	



11. Notes



EG-Declaration of conformity

1/WT/2019

Manufacturer: **Wire- Trade UG (Haftungsbeschränkt)**
Am Schöps 103
02829 **Markersdorf, Germany**

confirms this product

Type: **WT6100**

Serial Number: 610000 to 610200

Description: an electric machine for cutting lines,
compliant with the following provisions:

European Directives : 2004/108/EG from 15. Dezember 2004 on the electromagnetic
compatibility and the machine direction line 2006/42/EG

Harmonized standards: EN ISO 13857:2008-06
EN ISO 12100:2011-03
EN 349:2008-09
EN 60204-1:2007-06
EN 61000-6-2:2006-03
EN 61000-6-3:2011-09

This explanation applies only to the machine in the state in which it has been placed on the market and
excludes components added or altered by the end user.

Documents authorized representative: Karim Ben Slimane

Adress: Am Schöps 103
02829 Markersdorf, Germany

Place, date: Markersdorf, den 24.10.2019

Karim Ben Slimane



13. Principle switch safety function

